

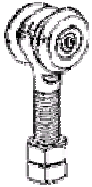

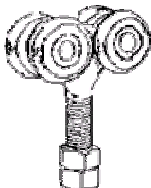

Carrelli

Monorotaia TA (80 G)
 Spessore 30 / 10 = Kg / ml 6,19

	Sigla	Caratteristiche	Portate Kg
	2RA	Carrello scorrevole Corpo fisso in acciaio forgiato e zincato Ruote tornite e zincate Ø 55	Per 2 carrelli Kg.420
	4RA	Carrello scorrevole Corpo fisso in acciaio forgiato e zincato Ruote tornite e zincate Ø 55	Per 2 carrelli Kg.780 Supporto monorotaia ogni 70 cm.
	2RAL	Carrello scorrevole con cerniera 1 ALA per porte a libro Corpo in acciaio forgiato e zincato Ruote tornite e zincate Ø 55	Per 2 carrelli Kg. 420 Supporto monorotaia ogni 70 cm.
	4RAL	Carrello scorrevole con cerniera 3 ALI per porte a libro Corpo in acciaio forgiato e zincato Ruote tornite e zincate Ø 55	Per 2 carrelli Kg. 780 Supporto monorotaia ogni 70 cm.
	4RALL	Carrello scorrevole con cerniera 1 ALA per porte a libro Corpo in acciaio forgiato e zincato Ruote tornite e zincate Ø 55	Per 2 carrelli kg. 780 Supporto monorotaia ogni 70 cm.

 = materiale disponibile a magazzino

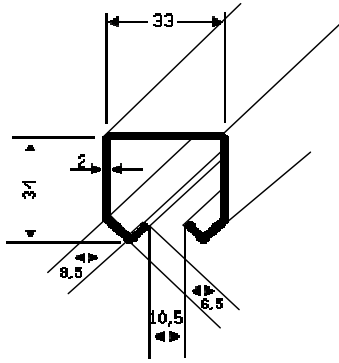

Monorotaia TC
Spessore 20/ 10 = kg/ ml 3,60

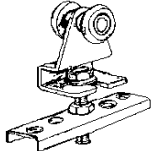
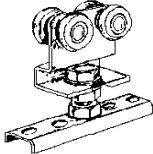
	Sigla	Caratteristiche	Portate Kg
	2RC	Carrello scorrevole Corpo in lamiera stampata e zincata Ruote tornite e zincate Ø24	Per 2 carrelli kg.50
	4RC	Carrello scorrevole Corpo in lamiera stampata e zincata Ruote tornite e zincate Ø24	Per 2 carrelli kg.75



Viti per fermavetro
(per TR3)
IN NYLON O ZINCATE



Copriangoli per fermavetro zincati
mm10/ mm 12

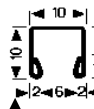

Fermavetro a scatto
TR3 10
LUCIDO O ZINCATO





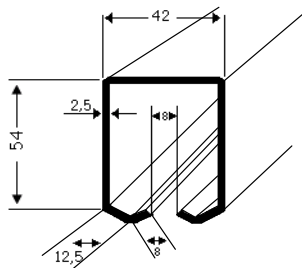

Fermavetro a scatto
TR3 12
LUCIDO O ZINCATO

 = materiale disponibile a magazzino

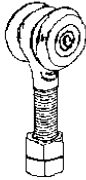
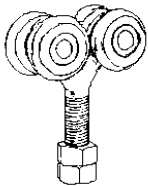

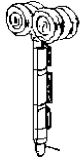
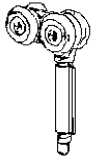
Monorotaia TB (80P)
Spessore 25/ 10 = kg/ ml 3,34

	Sigla	Caratteristiche	Portate Kg
	2RB	Carrello scorrevole Corpo in acciaio forgiato e zincato Ruote tornite e zincate Ø 45	Per 2 carrelli Kg. 220 Supporto monorotaia ogni 70 cm.
	4RB	Carrello scorrevole Corpo in acciaio forgiato e zincato Ruote tornite e zincate Ø 45	Per 2 carrelli Kg. 670 Supporto monorotaia ogni 70 cm.
	2RBL	Carrello scorrevole con cerniera a 1 ALA per porte a libro Corpo in acciaio forgiato e zincato Ruote tornite e zincate Ø 45	Per 2 carrelli Kg. 220 Supporto monorotaia ogni 70 cm.
	4RBL	Carrello scorrevole con cerniera a 3 ALI per porte a libro Corpo in acciaio forgiato e zincato Ruote tornite e zincate Ø 45	Per 2 carrelli Kg. 670 Supporto monorotaia ogni 70 cm.
	4RBLL	Carrello scorrevole con cerniera a 1 ALA per porte a libro Corpo in acciaio forgiato e zincato Ruote tornite e zincate Ø 45	Per 2 carrelli Kg. 670 Supporto monorotaia ogni 70 cm.

 = materiale disponibile a magazzino